

ADJUSTABLE STEEL GANTRY CRANE - KNOCKDOWN - AHSN-2-20-12

APPROX WEIGHT: 1064.09 lbs.
DOES NOT INCLUDE WEIGHT OF POWER OR PACKAGING!!!

*** ANY ADDITIONS, DELETIONS, OR OMISSIONS MUST BE CORRECTED ON THIS DRAWING AS THIS DRAWING WILL BE CONSIDERED ALL INCLUSIVE ***
ALL GRAPHICS PROVIDED ARE FOR REFERENCE ONLY. IF CERTAIN DIMENSIONS ARE CRITICAL PLEASE VERIFY THOSE DIMENSIONS WITH YOUR SALESPERSON

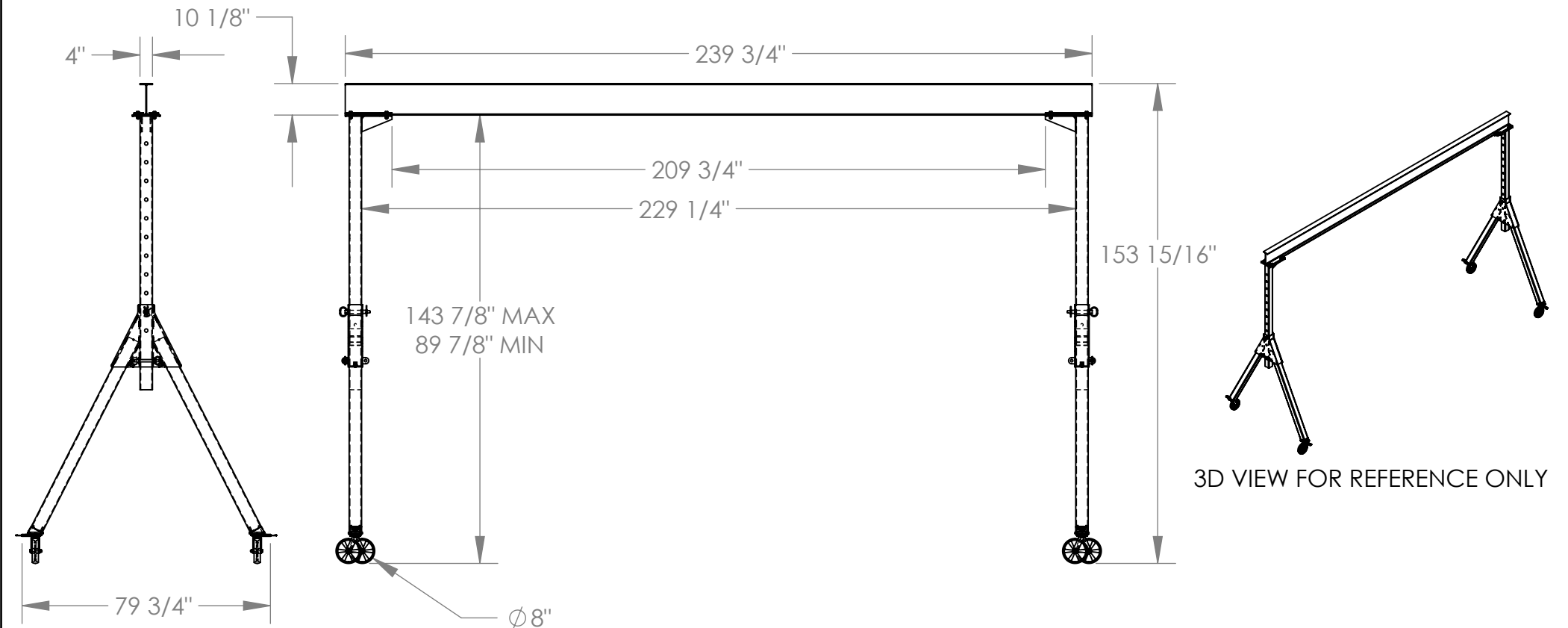

STANDARD FEATURES

- MODEL NUMBER IS AHSN-2-20-12
- CAPACITY IS 2,000 LBS.
- BASE WIDTH IS 79 3/4"
- MAX OVERALL HEIGHT IS 153 15/16"
- I-BEAM HEIGHT IS 10 1/8"
- I-BEAM FLANGE WIDTH IS 4"
- OVERALL I-BEAM LENGTH IS 239 3/4"
- USABLE I-BEAM LENGTH IS 209 3/4"
- ADJUSTABLE UNDER I-BEAM HEIGHT
 - 143 7/8" MAX
 - 89 7/8" MIN
- HEIGHT IS ADJUSTABLE IN 6" INCREMENTS
- CASTERS: (4) Ø8" X 2" WIDE GLASS FILLED NYLON SWIVEL CASTERS WITH FOUR LOCKING POSITIONS

SPECIAL FEATURES

NONE

DIMENSION TOLERANCE ± 1/4"

APPROVAL

I, THE UNDERSIGNED, AGREE THAT THE PRODUCT AS REPRESENTED SATISFIES DESIGN AND DIMENSION REQUIREMENTS. I ALSO ACKNOWLEDGE MY DUTY TO CONFIRM PRODUCT AND INSTALLATION COMPLIANCE WITH ALL APPLICABLE FEDERAL, STATE AND LOCAL REGULATIONS AND STANDARDS.

ANY MODIFIED UNITS ARE NON-RETURNABLE

[] As drawn [] As marked

Signed: _____ Date: _____

Printed Name: _____

LEAD TIME WILL START UPON RECEIPT OF SIGNED APPROVAL DRAWING

FOR INTERNAL USE ONLY PROJECT SIGN OFF	
SALES	
ENG.	
FAB.	
POWER	

DISTRIBUTOR'S NAME:		P.O.#
VESTIL MANUFACTURING		X
DRAWN BY: DLS		W.O.#
DATE: 06/30/14		X
REFERENCE: X	SCALE: 1:46	SALES: X
QUOTED LEAD TIME: X	QUOTE #	FILE NAME:
	X	28-007-307