

STEEL TRUCK DOCKBOARD - TS-30-7260

APPROX WEIGHT: 834.74 lbs.
 DOES NOT INCLUDE WEIGHT OF POWER OR PACKAGING!!!

*** ANY ADDITIONS, DELETIONS, OR OMISSIONS MUST BE CORRECTED ON THIS DRAWING AS THIS DRAWING WILL BE CONSIDERED ALL INCLUSIVE ***

ALL GRAPHICS PROVIDED ARE FOR REFERENCE ONLY. IF CERTAIN DIMENSIONS ARE CRITICAL PLEASE VERIFY THOSE DIMENSIONS WITH YOUR SALESPERSON

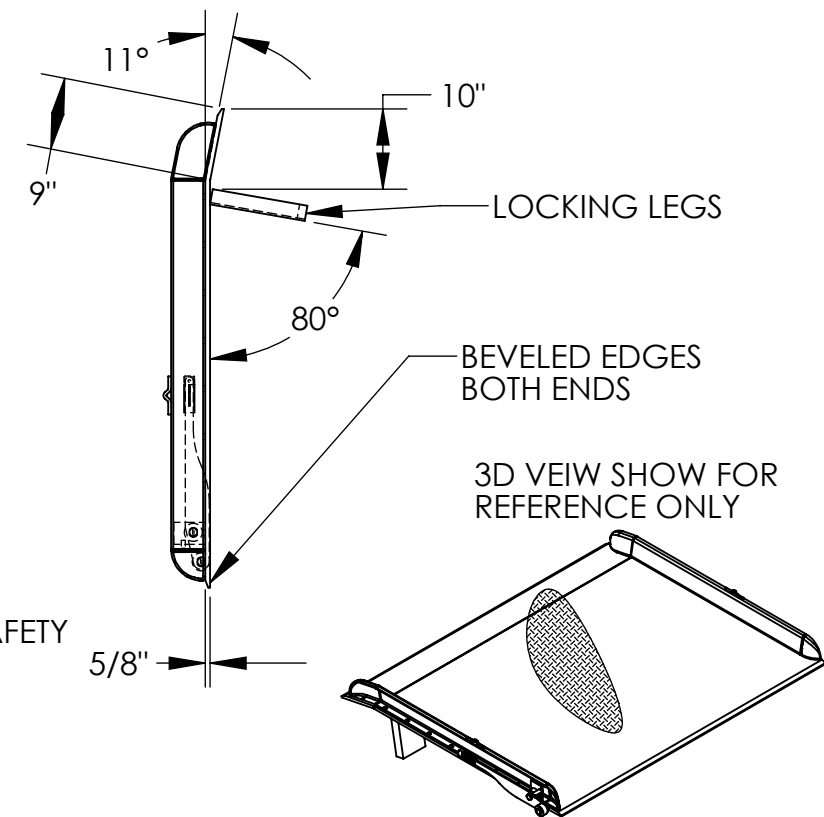
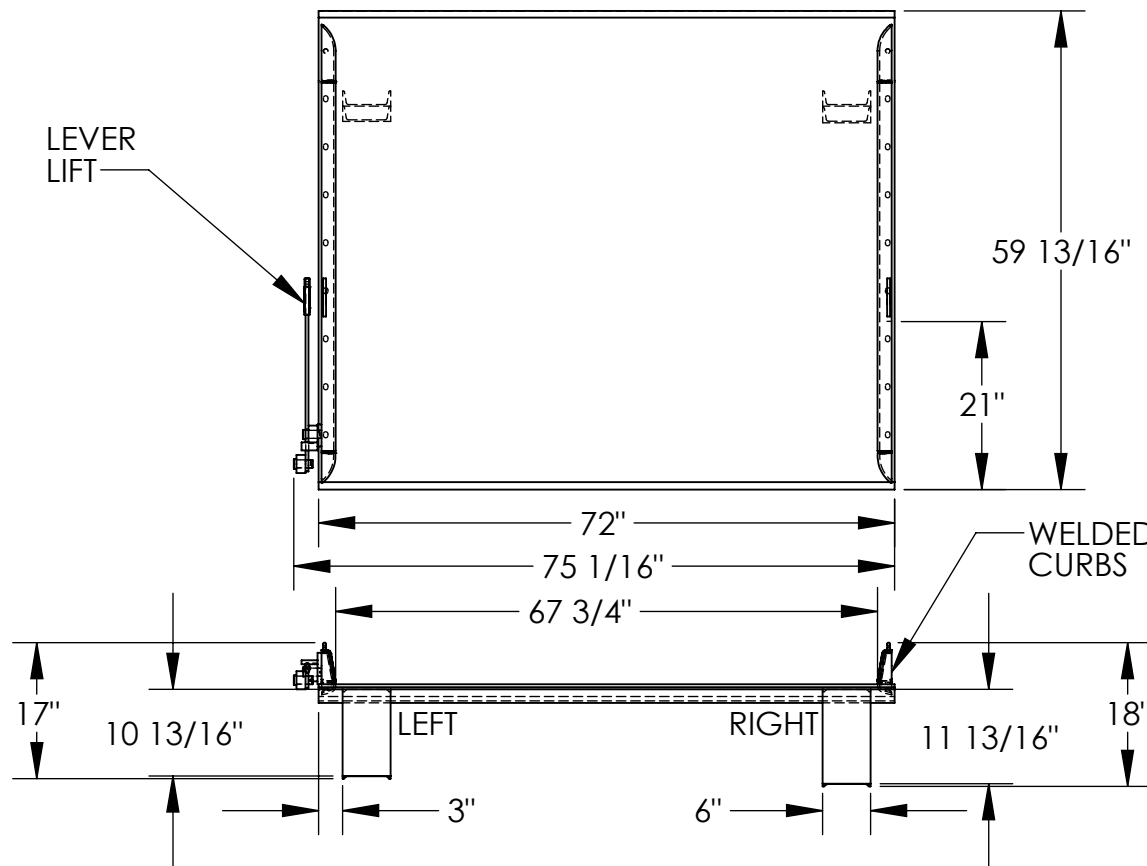

DIMENSION TOLERANCE ± 1/4"

STANDARD FEATURES

- MODEL NUMBER: TS-30-7260
- CAPACITY: 30,000 LBS
- OVERALL WIDTH: 75 1/16"
- OVERALL LENGTH: 59 13/16"
- DOCKPLATE THICKNESS: 5/8"
- LEVER LIFT IS STANDARD
- LOCKING LEGS ARE 6" WIDE
- RIGHT LEG LENGTH IS 11 13/16"
- LEFT LEG LENGTH IS 10 13/16"
- CROWN IS 11° & 9" FROM EDGE
- HEIGHT DIFFERENCE: 10"
- DURABLE LIQUID PAINT BLUE FINISH

SPECIAL FEATURES

NONE

APPROVAL

I, THE UNDERSIGNED, AGREE THAT THE PRODUCT AS REPRESENTED SATISFIES DESIGN AND DIMENSION REQUIREMENTS. I ALSO ACKNOWLEDGE MY DUTY TO CONFIRM PRODUCT AND INSTALLATION COMPLIANCE WITH ALL APPLICABLE FEDERAL, STATE AND LOCAL REGULATIONS AND STANDARDS.

ANY MODIFIED UNITS ARE NON-RETURNABLE

[] As drawn [] As marked

Signed: _____ Date: _____

Printed Name: _____

LEAD TIME WILL START UPON RECEIPT OF SIGNED APPROVAL DRAWING

FOR INTERNAL USE ONLY PROJECT SIGN OFF	
SALES	
ENG.	
FAB.	
POWER	

DISTRIBUTOR'S NAME:		P.O.#
VESTIL MANUFACTURING		X
DRAWN BY: ADL		W.O.#
DATE: 12/21/2005		X
REFERENCE: X	SCALE: 1:24	SALES: X
QUOTED LEAD TIME: X	QUOTE #	FILE NAME:
	X	10-007-150